

Box tetto / Roof boxes

> SPARK

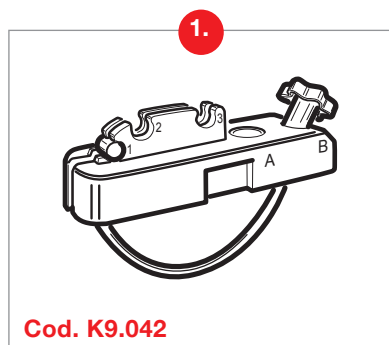





Guarantee
5
years

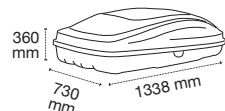

1. Kit di fissaggio
2. Sollevatore a molla
3. Serratura pulsante
4. Serratura centralizzata

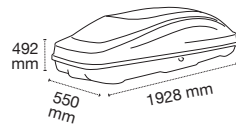
1. Fixing kit
2. Spring jacks
3. Push-button lock
4. Centralized lock

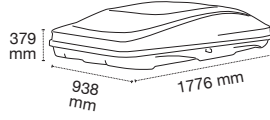
R1 **PS** **UV** **CityCrash**

	CODE	EAN CODE	MAX LOAD	NET WEIGHT	GROSS WEIGHT	CAPACITY	OPENING	LOCK	FIXING STRAPS	PACK VOLUME
  <p>SPARK 320</p>	22.400	8010682039382	50 Kg	7 Kg	10 Kg	240 lt	right side	1 push button	yes	0,366 m ³
  <p>SPARK 420</p>	22.405	8010682038491	50 Kg	12 Kg	16 Kg	370 lt	 Dual Side V	2 centralized	yes	0,548 m ³
  <p>SPARK 520</p>	22.406	8010682044591	75 kg	16,4 kg	21,4 kg	420 lt	 Dual Side V	2 centralized	yes	0,635 m ³